



INSIDE

03 About IGSTC

04 Governing Body & Finance Committee Meetings

06 2+2 Projects

07 Fibre optic sensor probes to detect waterborne pathogens

10 A novel software tool for advanced biomechanical simulation of patient corneas

11 Integrated solar dryer and pyrolysis pilot plant will help smart cities transform urban organic waste into biochar & energy

13 An integrated product for cartridge based in-line deployable/portable tests for pathogens and pharmaceutical residues in water

15 New projects initiated on bioeconomy

20 Workshops

21 Innovative charging technologies for heavy duty vehicles

23 Advanced automotive steels

25 High-performance metallic materials for energy storage and power generation

27 IGSTC partners meet

28 Robotomation – Symposium for robotic automation trends in manufacturing

29 Indo-German forum on cities & climate

Editorial Team

Editor
P V Lalitha

Associate Editor
Saquib Shaikh

ABOUT IGSTC

For IGSTC the year 2021 started with the joining of its new Director Mr R. Madhan. The 11th Governing Body Meeting and the 5th Finance Committee meeting took place during this quarter. IGSTC also held Partners Meet for ongoing projects under different Calls to discuss on project progress, implementation and related activities.

IGSTC through its flagship program '2+2 Projects', catalyses innovation centric R&D projects by synergising the strength of research and academic institutions and public/private industries from India and Germany. Phase 2 of four projects is progressing well towards technology commercialisation. Multi-WAP project in Phase 2 partnered by IIT Madras, Chembiosens, TU Braunschweig & Lionex GmbH have resulted in the development of fiber optic sensors for detecting waterborne pathogens. The sensor technology will help in detecting waterborne pathogens at low cost and high sensitivity. They also incorporated a start-up Chembiosens resulted from the project funding to develop and manufacture the sensor platforms. A novel software tool for advanced biomechanical simulation of patient corneas called AcuSimX has been successfully launched by the project SIBAC (Phase 2) partnered by Narayana Nethralaya Foundation and Oculus Optikergate. It is the world's first advanced simulation software for surgeons to perform virtual surgery and study the effects of different parameters for stability of corneas. This will significantly help perform better surgeries on corneas. The foundation stone for the Integrated solar dryer and pyrolysis plant was laid down at CSIR-CLRI under project Pyrasol. The project is partnered by CSIR-CLRI, Ramky Enviro, Leibniz University and Biomacon. The plant will help smart cities to convert transform urban organic waste into biochar & energy. The story was covered by DD News.

IGSTC promotes Workshops to facilitate new associations and joint collaborative research projects among scientists/technologists between the two countries. Three workshops under the Virtual workshop Call in the areas of advanced automotive steels, charging technologies for heavy duty vehicles and energy storage were organized. Approximately 800 Indian & German scientists, policy officers, young researchers and technologists benefitted from these workshops.

During these challenging COVID-19 pandemic times IGSTC is making all efforts to support all project partners for smooth implementation of projects.

IGSTC intends to start a new programme on Industrial Fellowships over the course of the year to support PhD and Post Docs to avail industrial experience.

Governing Body & Finance Committee Meetings

The 11th Governing Body (GB) meeting of IGSTC was held on 4th March 2021 through virtual mode. The GB members are Mr S. K. Varshney (DST & Indian Co-chair), Ms Kathrin Meyer (BMBF & German Co-chair), Mr Vishvajit Sahay (DST), Dr Gerold Heinrichs (DLR-PT) Prof. Sandeep Verma (SERB), Ms Andrea Frank (Stifterverband), Dr G Padmanabham (ARCI), Mr Philipp Ritter (German Embassy, New Delhi), Mr Sanjeev Rangrass (ITC), Dr Clas Neumann (Vice President, SAP). Dr Ulrike Wolters (BMBF) and Dr Sibashisa Das (DST) are member secretaries.

Mr R. Madhan (Director), Dr P V Lalitha, Mr R Varadarajan, Mr Hans Westphal and Alexandra Stinner (DLR-PT) represented IGSTC in the meeting. The GB focused holistically on IGSTC's 2 + 2 flagship programme, thematic areas for future grant calls and new programmes to be taken up etc. GB also expressed their gratitude to the outgoing GB members Prof Eberhard Abele and Mr Anjan Das.

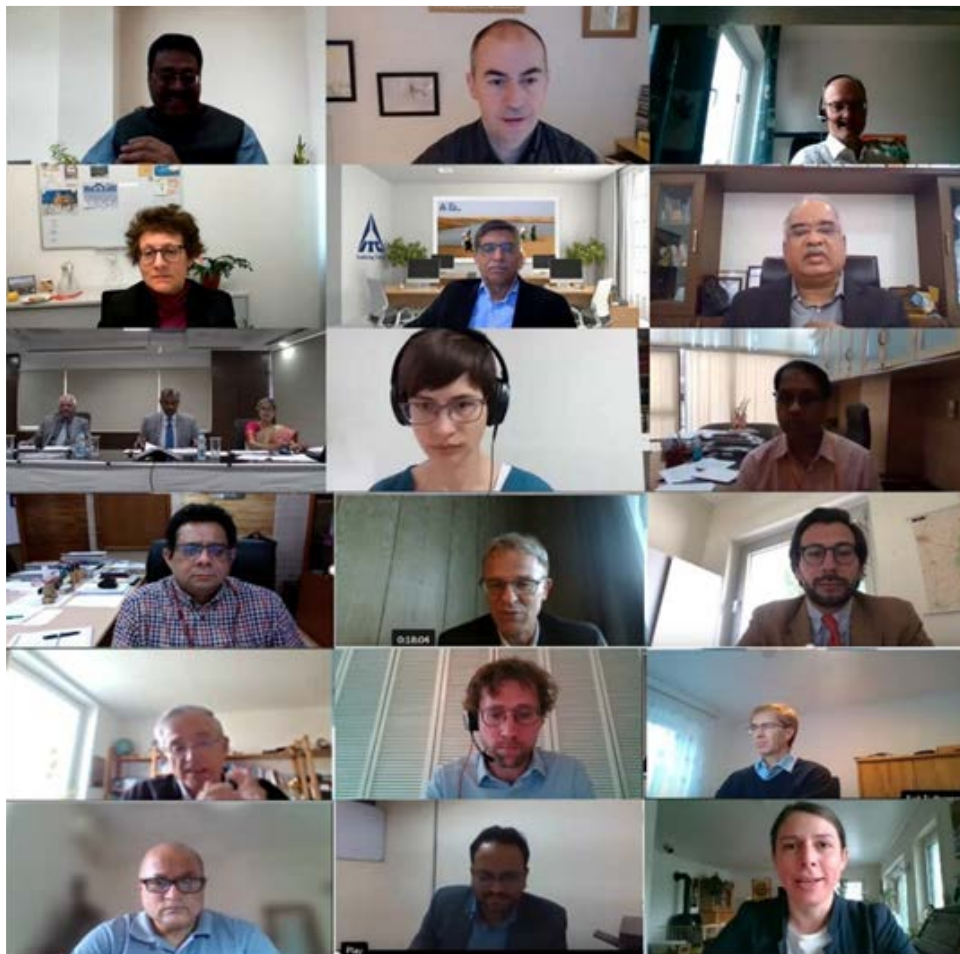

11th GB Meeting through web-conferencing

The 5th Finance Committee (FC) meeting took place on 23rd February 2021 through virtual mode. The FC comprises of Mr Vishvajit Sahay (Financial Advisor, DST and Indian Co-Chair of FC), Dr Gerold Heinrichs (DLR-PT and German Co-Chair of FC), Dr Ulrike Wolters (BMBF) and Dr Sibashisa Das (DST).

Mr R. Madhan (Director, IGSTC), Mr R Varadarajan (Manager, IGSTC), Mr Pravin Gupta (Financial consultant), Mr Hans Westphal (DLR-PT/IGSTC) attended the meeting for IGSTC. Discussions was focused on financials, audit report and budget estimates for IGSTC.



5th Finance Committee (FC) Meeting

2+2 Projects

There are currently 23 ongoing 2+2 projects. The following section highlights some of the projects.

Fibre optic sensor probes to detect waterborne pathogens

Project Title

Multi-WAP: Multiplexed, label-free fiber optic biosensor array system for waterborne pathogen detection (Phase 2)

Project Investigators



V V Raghavendra Sai
IIT Madras
Chennai



A Subrahmanyam
ChemBioSens Pvt Ltd
Chennai



Claus-Peter Klages
TU Braunschweig
Braunschweig



Mahavir Singh
Lionex GmbH
Braunschweig

V I Bishor, Ubio biotechnology systems, Cochin was the industrial partner in Phase 1

During the Phase 1 of the Multi-WAP project, each of the partners including the Biosensors Laboratory at IIT Madras, ubio biotechnology systems Pvt Ltd, Cochin, Institute for Surface technology (IOT) at Technical University Braunschweig and Lionex Diagnostics and Therapeutics GmbH, Braunschweig have brought their expertise in their respective domains to successfully demonstrate the concept of fiber optic array sensor for the multiplexed and simultaneous detection of up to 6 different waterborne pathogens. While IIT Madras developed the instrumentation for the fabrication of highly sensitive U-bent fiber optic probes and fiber optic array sensor system, IOT focused on efficient atmospheric plasma-based surface modification for fiber optic sensor probes. Lionex developed antibodies for a select pathogenic bacteria. Besides the close cooperation between

the Indian and German partners, this project has enabled the team to explore new avenues including a cooperation for development of an affordable tuberculosis diagnostic device. The funding support to the project partner at IIT Madras has led to not only the student exchange visits, several journal publications, innovations and patents based on the outcomes of this project, but also a start-up focused on chemical and bio sensing applications.

In the extension phase (Phase 2), named as DEMO-Multi-WAP, the project aims to demonstrate the technology at TRL-7, to take the work a step closer towards the commercialization. ChemBioSens Pvt Ltd, a start-up incubated at IIT Madras and which has its genesis from the Phase 1 of this project, has joined the consortium as an Indian industry partner with an intention to take

the technology being developed under this project forward and identify the avenues for its application. For this process, ChemBioSens is supported by IGSTC with a grant-in-aid, up to 50% of the project expenses. The Indian and German partners are working towards reaching their milestones in spite of the difficulties posed by the COVID-19 crisis. In addition to environmental monitoring, the proposed fibreoptic array biosensor (FAB) technology has a strong potential in clinical diagnostics and biomolecular interactions, which are important for pharmaceutical industry.

The technologies developed under the project are briefly summarised below:

a) Automated fiber bending machine to fabricate disposable fiber optic sensor probe for the array biosensor

One of the significant achievements is the development of the automated fiber bending machine to fabricate U-fiber optic probes with high consistency in the probe geometry and hence the reproducible sensitivity. Currently, about 50 U-bent fiber optic probes are produced in a day. While the fiber bending takes only 1 minute, the pre and post processing including decladding and polishing of the distal ends for efficient optical coupling involves manual process and consumes a significant time and effort.

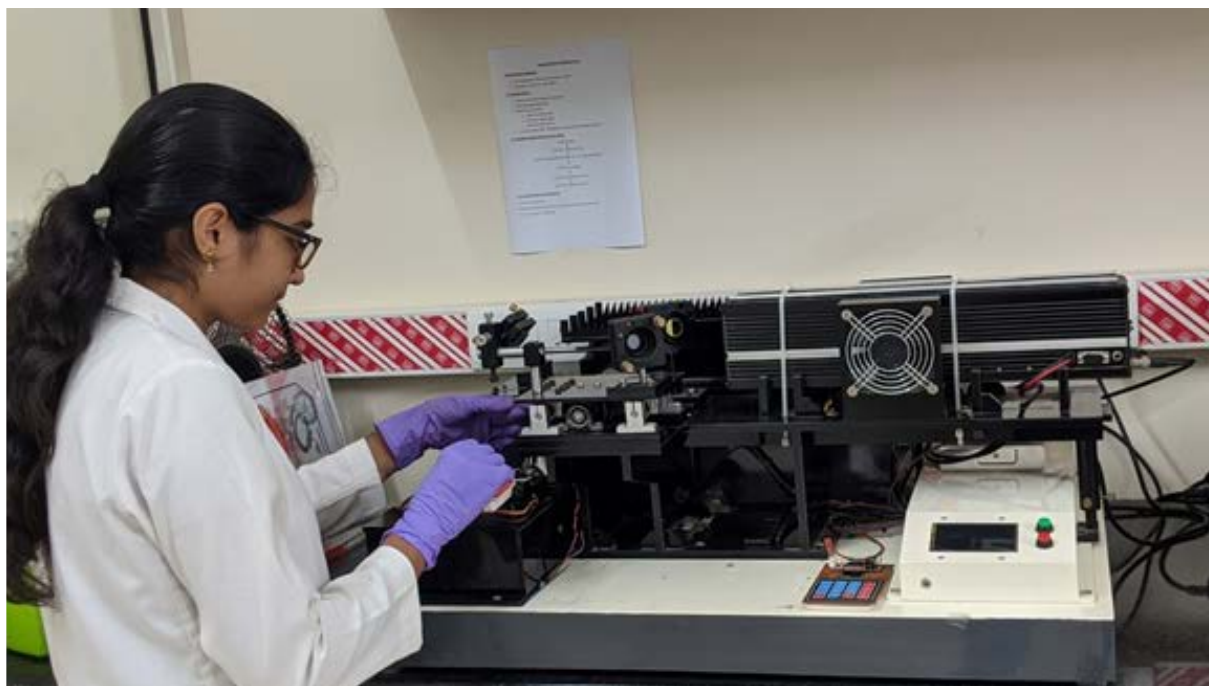

Fiber Bending Machine: CO₂ laser based fiber bending machine to fabricate highly sensitive u-bent probes

b) Fiber optic array biosensor with sensor platform for detection of waterborne pathogens

The other achievement is the development of the fiber optic array biosensor with an UV LED and UV sensitive CMOS detector with UV-active fiber bundles for light propagation between the U-bent

probes and the light source/detector. The issues with the previously conceived design for the precise alignment of the probe ends with that of fibers in bundles (due to machining limitations) were overcome by using the ceramic ferrules (<5micron concentricity) at the fiber ends and mating sleeves to align the two ferrules.



Fiberoptic Array Biosensor: A Compact array biosensor with 8 probes for simultaneous detection of up to 7 different pathogens of interest.

Both the above technologies have been commercialised in the following forms:

- An IP license agreement with Ricovr Healthcare Inc, USA to transfer the technology on fiber optic sensing for sensitive and fast application in the field of oral diagnostics.
- Incorporation of ChemBioSens Pvt. Ltd. (<https://chembiosens.com/>), a start-up company as a spin-off of the technology development activities at the Biosensors Laboratory at IIT Madras enabled by the IGSTC

project funding on 23/10/2018 at IIT Madras Incubation Cell.

The sensor technology developed can detect pathogens in a water sample pre-mixed with concentrated phosphate buffer saline in less than 30 min. This is one of the important advantages over the conventional techniques including cell culture and nucleic acid amplification tests. Such sensor technology helps India in faster and reliable detection of pathogens in water resources at low cost and high sensitivity (>90%).

A novel software tool for advanced biomechanical simulation of patient corneas

Project Title

SIBAC: Development of a software tool for predictive modeling of corneal deformation with air-puff applanation (Phase 2)

Project Investigators



Abhijit Sinha Roy
Narayana Nethralaya
Foundation, Bangalore



Sven Reisdorf
OCULUS Optikgeräte
GmbH, Dresden

Everette Nelson, VIT University; Shyam Vasudevrao, Forus Health and Eberhard Spoerl, University of Carl Gustav Carus were Partners in Phase 1 of The Project

The SIBAC consortium (partnered by Narayana Nethralaya Foundation, Bangalore; OCULUS Optikgeräte GmbH, Dresden) in phase 2 developed a novel software tool for advanced biomechanical simulation of patient corneas and to use the software for predicting biomechanical outcomes after refractive surgery and for diagnosis of corneal degenerations such as keratoconus. In addition, the SIBAC project has resulted in the development and launch of the world's first advanced simulation software called AcuSimX™. The objective of AcuSimX is to combine 3-D tomography of corneas and mechanical deformation measurements from Corvis-ST (OCULUS Optikgerate GmbH, Germany) into an inverse finite element model refined by artificial intelligence to yield post-operative corneal biomechanical stiffness before any surgery or intervention is performed. Thus, the surgeons can perform a virtual surgery using AcuSimX and also test the effect of different surgical parameters on possible biomechanical stability of the corneas. OCULUS Optikgerate GmbH Asia has also agreed to market and promote the software in South-East Asia, China and Australia

in the first round of commercialization with no financial overheads. AcuSimX will be marketed and sold by through Narayana Ophthalmic Research and Development LLP and OCULUS Optikgerate GmbH Asia to customers.

The software will help in planning surgeries better by quantifying the different biomechanical properties of corneas and the outcomes will become better.

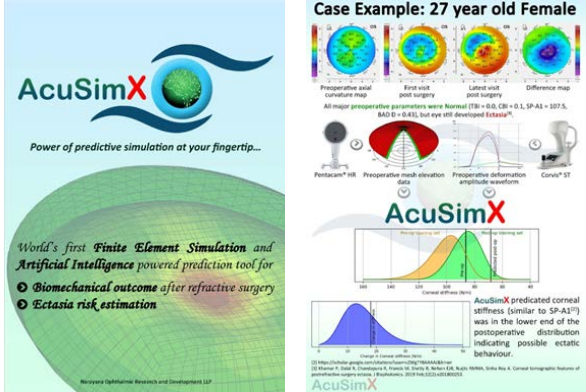

A Snapshot of the brochure of software AcuSimX

Integrated solar dryer and pyrolysis pilot plant will help smart cities transform urban organic waste into biochar and energy

Project Title

Pyrasol: Smart Cities integrated energy supply, carbon sequestration and urban organic waste treatment through combined solar sludge drying and pyrolysis

Project Investigators



S V Srinivasan
CSIR-CLRI
Chennai



Santosh Kumar
Ramky Enviro Engineers
Chennai



Dirk Weichgrebe
Leibniz Universität
Hannover



Ulrich Suer
Biomaccon GmbH
Rehburg

The project focus was to manage and organize collection, treatment, and disposal systems of urban wastes in Indian Smart Cities as well as in other urban centers with an integrated and interactive approach. Through the Pyrasol project, simple and robust processing technologies for urban organic waste will be combined in a synergetic manner and further developed to improve sanitation and welfare, supply regenerative energy, convert waste into products and reduce the carbon footprint of Smart Cities by an innovative organic waste drying system using the solar natural chimney effect followed by a highly efficient single-chamber pyrolysis. The aim of the project is to offer an innovative approach for smart cities

to transform urban organic waste into biochar and energy. The project will ultimately lead to technology development for the joint processing of Fibrous Organic Waste (FOW) and Sewage Sludge (SS) of Indian smart cities into hygienic and highly valuable biochar associated with energy recovery, carbon sequestration and environmental improvement.

The project has resulted in the development of an Integrated solar dryer and pyrolysis pilot plant. The foundation stone for the pilot plant was laid by Dr. K J Sreeram, Director, CSIR-CLRI on the occasion of 74th foundation day of CLRI on 23rd April 2021.



Dr K.J. Sreeram, Director, CSIR-CLRI inaugurating the foundation stone of integrated solar dryer and pyrolysis plant

Congratulations to the teams from CSIR-CLRI, Chennai; Ramky Enviro Engineers, Chennai; Leibniz Universität, Hannover and Biomacon GmbH, Rehburg for the progress they achieved in the technology development.





CLRI Project Team

An integrated product for cartridge based in-line deployable/portable tests for pathogens and pharmaceutical residues in water

Project Title

IDC-Water: Integrated diagnostics of contaminants in water supply and management system

Project Investigators

			
D Roy Mahapatra IISc Bangalore	J Manjula Bigtec Labs Pvt. Ltd. Bangalore	Rudolf J. Schneider BAM, Berlin	Michael Voetz Sifin diagnostics GmbH, Berlin

In India, water-related diseases account for around 80% of premature deaths. The most common and widespread health risk associated with drinking water is microbial contamination. The organisms causing water contamination are many, out of which E. coli, Salmonella, Shigella, and Rotavirus are of interest for their detection and monitoring. The project aims to develop a system for monitoring bacteria and pharmaceutical residues. It comprises an in-line system for remote monitoring and a portable micro-PCR-based device for detailed analysis in mobile or test laboratory settings.

Project partners are meeting virtually on monthly basis to discuss on the progress. In the meetings held on 17th March and 20th April, the partners discussed test results from the prototype detection units. Key features of the system are the

robustness of the assays for bacterial cells, nucleic acid, and pharmaceuticals. Detection sensitivity tests have been performed with Diclofenac immunoassay by BAM and Sifin. Bigtec and IISc are supporting that effort towards cartridge development for integration into the monitoring system. A modular approach in design and test procedure with cartridges is getting developed. Bigtec has established the limit of detection for Shiga toxic E. coli DNA in water samples using its micro-PCR device. This effort is towards creating a PCR assay to detect total bacteria and target pathogens such as shigella, salmonella, and E. coli with selective primer/probe with high specificity. The partners also discussed various aspects of integration of operational process flows in the water quality monitoring system.



IDC-Water project team members at the partner meeting online

Some of the results have been published in peer-reviewed journal articles:

- Monitoring microbial growth on a microfluidic lab-on-chip with electrochemical impedance spectroscopic technique, Shaik et al. Biomedical Microdevices, 2021.
- Pitfalls in the Immunochemical Determination of β -Lactam Antibiotics in Water, Ecke et al. Antibiotics 2021, 10, 298.

New projects initiated on bioeconomy

Four projects under Call 2019 on bioeconomy were awarded and sanctioned year-1 grants to the Indian partners. The projects are in the areas of Vertical farming, sensor technology for soil testing and urban farming. A brief description on these projects is presented below.

Project Title

AutoNutri: On-site multi ion monitoring system for on-line nutrient-laden water control in vertical hydroponic systems to minimize environmental impact

Project Investigators

			
Uday Annapure ICT Mumbai	Vishal G. Warke HiMedia Laboratories P. Ltd, Mumbai	Karin Potje-Kamloth Fraunhofer IMM Mainz	Oliver Stegen RM Geraetebau Oliver Stegen Reinheim

One of the challenges in cultivation in a hydroponic system with closed irrigation system is the optimized nutrient regulation due to inaccurate information of composition, although many researchers describe the determination of concentration of individual ions in solution as the key information for optimized operation. Current practice is the determination of conductivity, pH, redox potential and temperature. The consequence is the limited possibility to adjust nutrients to the needs of individual crops to avoid deficiency or eutrophication. The operators therefore periodically drain and replace the nutrient solutions.

The aim of the project is to develop an on-site multi-ion monitoring system for automated on-line control of nutrient input in vertical hydroculture systems with closed circulation systems based on feedback-controlled supply of nutrients. The monitoring system enables the effective use of nutrients for optimal plant growth by targeted regeneration of nutrient solution and thus contributes to a reduction in water pollution due to the premature nutrient disposal into the environment. Nutrient monitoring is based on direct potentiometric determination of relevant ions

using ion-selective sensors. The choice of ions is characteristic of the growth of five crops selected. The sensors are integrated into a microfluidic system, which enables automated sample collection and adjustment of the measurement matrix. Calibration, data acquisition/ processing are carried out using "machine learning" algorithms developed in the project to compensate for non-linear effects due to ion interference/ cross-sensitivity and electrode/ temperature drift. Prototypes will be provided to end users in India for beta testing.







HiMedia R & D testing facilities at Igatpuri, India

Project Title

NOMIS: Non-enzymatic microfluidic electrochemical multiplex sensor for cost-effective soil testing

Project Investigators

			
Gorachand Dutta IIT Kharagpur	Amit Rastogi Coromandel International Ltd. Secunderabad	Bernhard Wolfrum TU Munich	Joachim Wiest cellasys GmbH Kronburg

Fertilizers and pesticides can exhibit moderate to lethal levels of toxicity in humans. Although they are used in farm-fields to boost agricultural productivity, these chemicals move up through the food chain, which leads to biomagnification. Most of the reported methods for the detection of fertilizer and pesticides in the soil are expensive, have a short shelf life, and are difficult to realize as a device outside laboratories. By combining the complementary expertise of the Indian and the German partners, the project aims to address this unmet challenge by developing an efficient multiplexed device for the detection of nitrate (a major fertilizer-based soil/ground water contaminant in India and Germany)

and organophosphates (a class of pesticides) in soil samples. The device will comprise a microfluidic platform integrated with printed electrodes based on analyte-sensitive ink formulations and will facilitate the regular screening of nitrate and organophosphates to monitor the quality of soil samples. Envisioned for commercial marketing, the device will be an important step towards sustainable agriculture, which will significantly improve the livelihood of rural farming communities in the countries and help in safeguarding water resources from pollution. Additionally, through the development of a user-friendly soil testing device in this project, awareness on environmental protection will be enhanced.

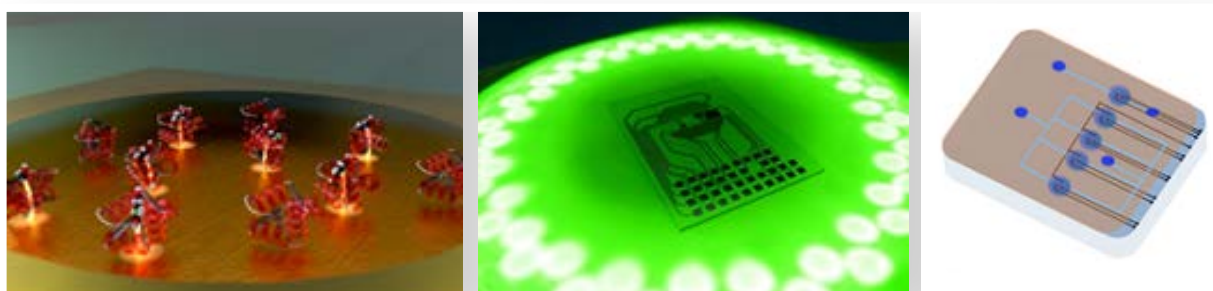

Nutrient sensor platform

Project Title

Circultex: Circular urban cultivation systems with re-useable textile growing substrates

Project Investigators



Harshata Pal
Amity University Kolkata



Sanjit Debnath
BCKV, Kalyani



Suhrid Chandra
HariMitti Agro P. Ltd.,
Kolkata



Bastian Winkler
University of
Hohenheim



Christoph Riethmueller
DITF, Denkendorf



Michael Walz
Eschler Textil GmbH, Balingen

Urban agriculture is integral part of sustainable city development, providing ecosystem services like air quality regulation, cooling, an appealing appearance and food production. Urban agriculture moved as trend into urban environments in form of vertical farming, rooftop and community gardening. Besides space, soil as cultivation substrate is scarce. Textile is light-weight and adaptive compared to other substrates and thus very suitable for soilless urban cultivation systems. The proposed project aims at the development of a re-useable textile cultivation substrate following a plant performance-based approach. In addition to plant and system specific properties, the dimensional stability of the textile will be taken into account during the development to allow for re-usability of the substrate through cleaning. Thermo-mechanical and a biological cleaning process

will be developed and evaluated. Subsequently, existing urban farming systems will be technically adapted to the textile substrate to improve resource-use efficiency and include an appropriate substrate cleaning process. In combination with a market analysis and target group segmentation (community gardening; urban farming for self-sufficiency; professional indoor, greenhouse and vertical farming) the value proposition and the financial feasibility will be translated into novel business models to support the market growth of urban farming. Circular, light-weight and resource-efficient urban farming with re-useable substrate may inspire urban inhabitants, triggers sustainable consumer behaviour and lead to a societal transition towards bioeconomy.



Plants Grown Using Textile Substrate © Bastian Winkler / Gruenfish e.V.

Project Title

Sensvert: Development and evaluation of automated sensors for a highly-efficient nutrition management system in indoor vertical farming

Project Investigators



Murtaza Hasan
ICAR-IARI
New Delhi



Shivendra Singh
Barton Breeze
Gurgaon



Heike Mempel
Hochschule
Weihenstephan-Triesdorf
Freising



Mohamed Bourouah
Hahn-Schickard
Schwenningen



Georg Brückner
Sondermaschinenbau
Brückner GmbH Marktgraitz

Vertical farming can make an important contribution to feed the growing global population especially in regions where the climatic conditions have significant restrictions on crop production. It is the practice of growing farm produce in vertical stacked layers with the help of soilless, hydroponic or aeroponic growing system. Vertical farms can be established in towns, cities, desert and degraded lands for growing high values nutritious vegetables

and fruits inside protected structures. Nutritional management through fertigation is the basic requirement in vertical farming as the plants are grown in inert media. Major and micronutrient management is the major task for successful vertical farming. Sensors for precise measurement, control and supply of nutrition to the plants will be used for detection of macronutrients, EC and pH for fertigation management.

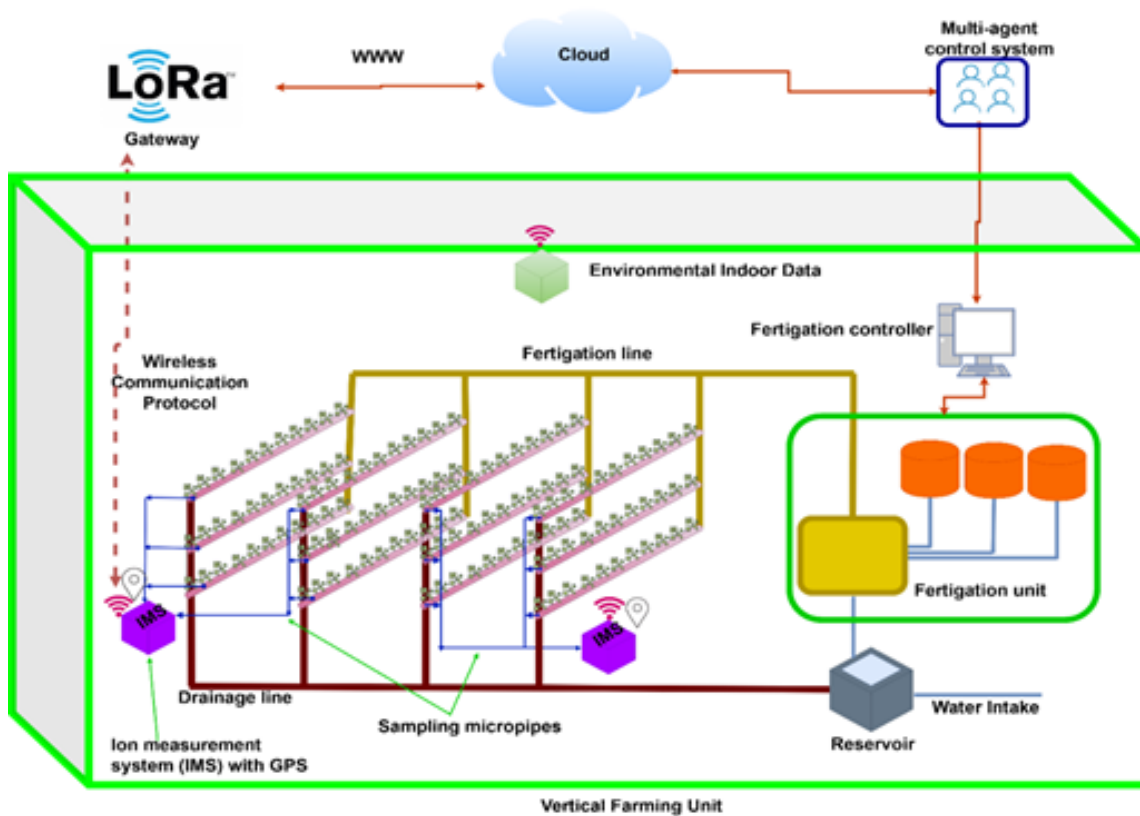

Overview of The Proposed Vertical Farming System



Vertical Farming Setup at Barton Breeze

Workshops

Three virtual workshops under the IGSTC special call for Indo-German bilateral virtual workshops were organised. These workshops were in the areas of innovative charging technologies, automotive steels and energy storage. The following pages brief on these joint workshops.

Innovative charging technologies for heavy duty vehicles (IChargeHDV)

18 February 2021

The Indo-German workshop on innovative charging technology for heavy duty vehicles (IChargeHDV) was organized on February 18, 2021, by ifeu – Institut für Energie- und Umweltforschung Heidelberg GmbH and The Energy and Resources Institute (TERI), New Delhi. The workshop co-ordinators were Mr Sharif Qamar, TERI and Udo Lambrecht, ifeu. It aimed to provide a platform for policy makers, infrastructure developers, research and development institutes, and leading industry players in freight transport technology/rolling stock supply to advance industrial research partnership in catenary truck technology, which is of interest for both the nations. This IGSTC supported joint Workshop, intended to enable stakeholders to share on-field experience in the

sector, combined with an overview of strategies to support each other in reducing the GHG emissions and pollutants from the freight transport sector. The workshop is one of the few first steps towards enhancing the technological partnership between nations under the ongoing bilateral projects like promotion of transformation to sustainable and climate friendly electro mobility by networking young scientists from India & Germany.

The workshop witnessed participation from various key stakeholders like leading scientists, policy persons, government officials, etc. from both the countries and involved serious deliberations on the benefits as well as challenges in the IChargeHDV sector.

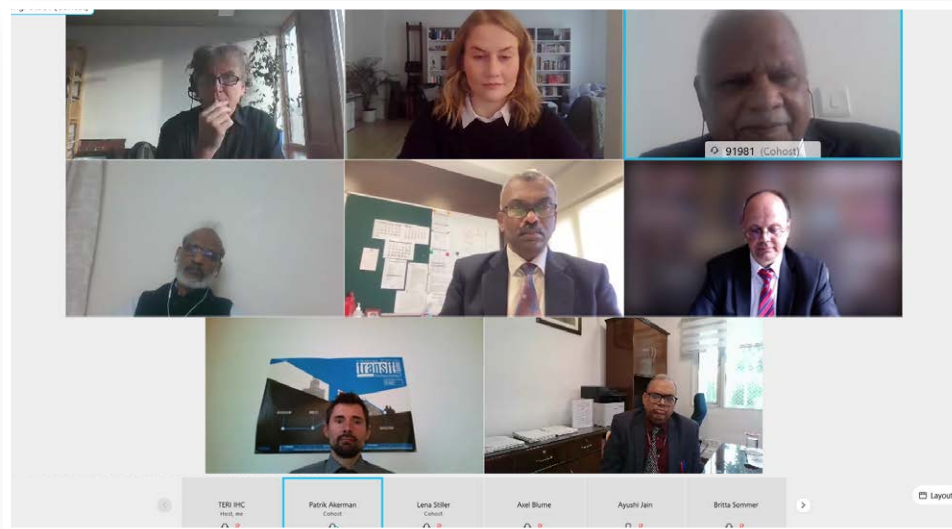

Welcome address of the workshop

The inaugural session was moderated by Ms Lena Stiller, Transport Policy Advisor, GIZ GmbH. Mr R Madhan, Director, Indo-German Science and Technology Centre (IGSTC) delivered the welcome address. He emphasized the need to build collaborations between industry and academia towards innovative and sustainable solutions. He encouraged that the outcome of the workshop may lead to initiate new bilateral cooperation through joint projects.

The joint opening remarks were delivered by Mr Udo Lambrecht, Board Member, ifeu (Germany) and Mr Shri Prakash, Distinguished Fellow, Transport & Urban Governance, TERI (India). Mr Lambrecht, Executive Board Member, ifeu, was pleased to see so many experts joining the virtual Indo-German workshop about innovative charging

technologies for heavy duty vehicles. He touched upon the climate crisis, which is becoming increasingly apparent and emphasized that the international community must push innovative approaches to reduce GHG in the coming years.

The workshop had different session on Pilot Project Steering & Management, Overhead Supply System Technology, E-Highways – Regulatory Framework, Retrofit Technology - Conventional to IMC, Platform for collaboration – Indian OEMs & R&D projects drawing key eminent scientists & speakers for the same.

The workshop resulted in key discussions regarding the requisites for electric highways and best possible ways to implement the project in India.

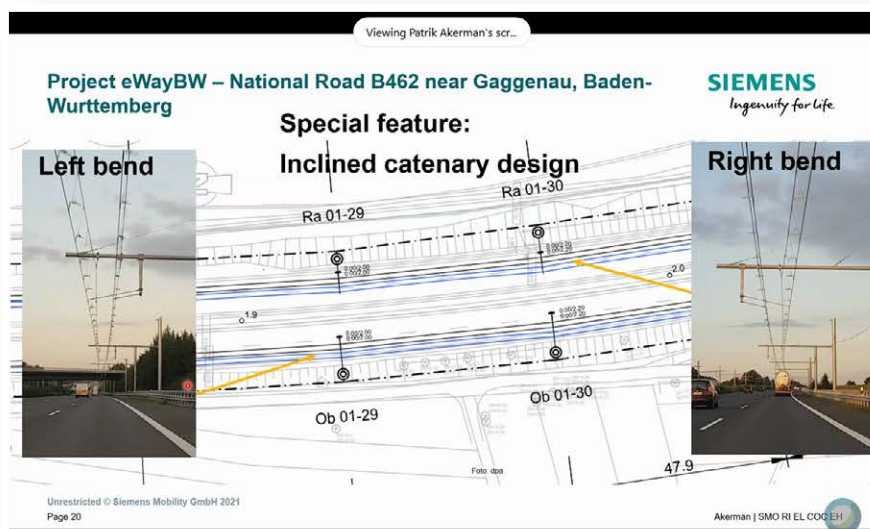

Indo-German workshop on advanced automotive steels (IGWAAS)

4-5 March 2021

IGWAAS - 2021 was jointly organized by both Indian and German academic partners, i.e. University of Hyderabad (UoH) and Universität Siegen (USI) respectively, in close collaboration with Indian and German industries, JSW Steel Works Ltd, Salem (JSW) and Mubea Fahrwerksfedern GmbH, Weissensee (MUB) respectively of IGSTC ongoing 2+2 project Steel4LTC on 4 – 5 March 2021. The workshop coordinators were Dr Koteswararao V. Rajulapati, UoH and Prof Robert Brandt, USI.

Steel is an important and indispensable structural material in automotive sector. In a continuous effort to make lightweight vehicles without compromising on efficiency, there have been several recent scientific and technological developments in the automotive steels. New grades of high strength steels (HSS) are being

adapted while considering lightweight, optimal design, safety missions and efficiency. Therefore, there is a need to understand the current trends and state of the art in steel development, fabrication and manufacturing technologies, microstructural development, mechanical properties, design, safety, fuel economy etc. The workshop discussed these trends in various steel grades that are currently employed in automotive vehicle manufacturing. The themes of the workshop represented an important aspect of high strength steel (HSS) such as steel making /hot forming, fatigue characteristics, low temperature creep and characterization.

The inaugural address was given by Prof Ulf Richter, Chancellor, University of Siegen and Prof P Appa Rao, Vice-Chancellor, University of Hyderabad.

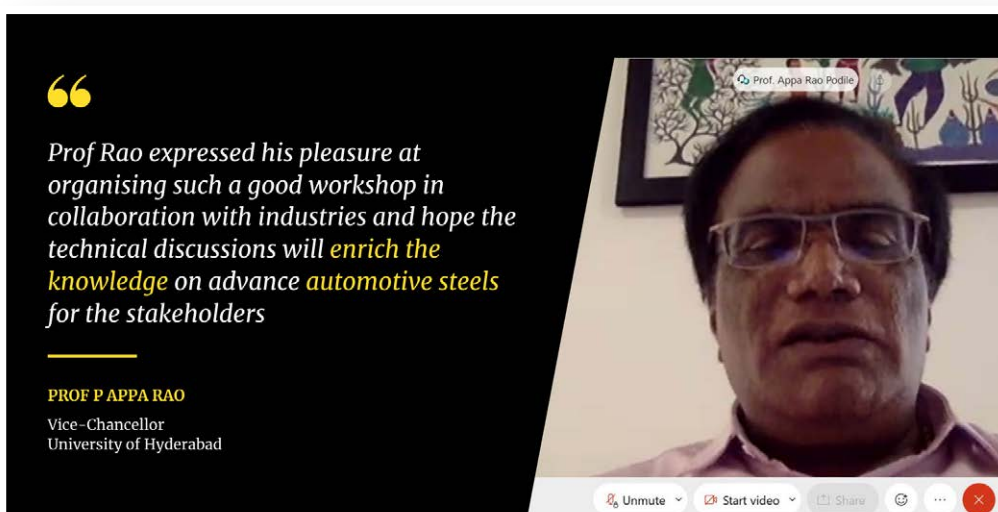

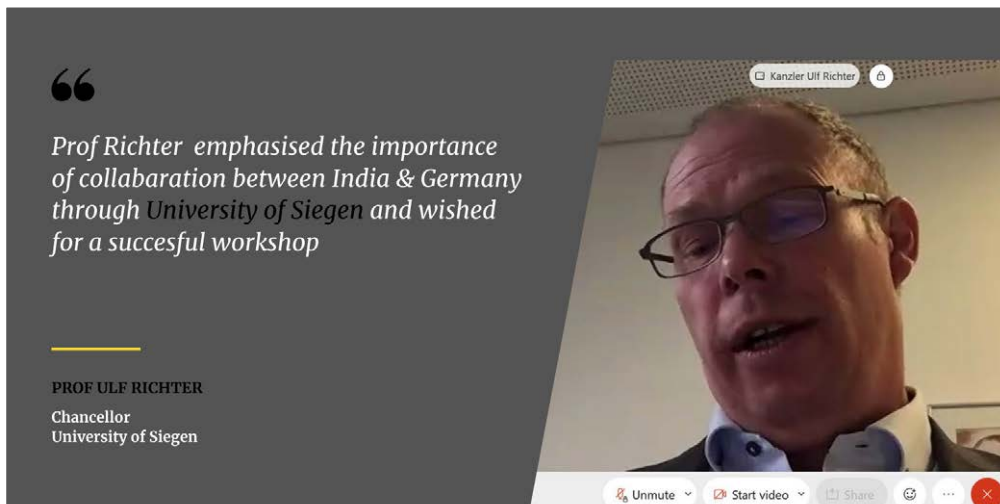

Mr R. Madhan, Director, IGSTC appreciated the efforts of organising such a wonderful workshop. He was hopeful that the networking through this workshop will lead to further joint collaborations

in applied research with the active involvement of industry. The workshop attracted more than 300 participants from academia, industry, govt. agencies, etc.

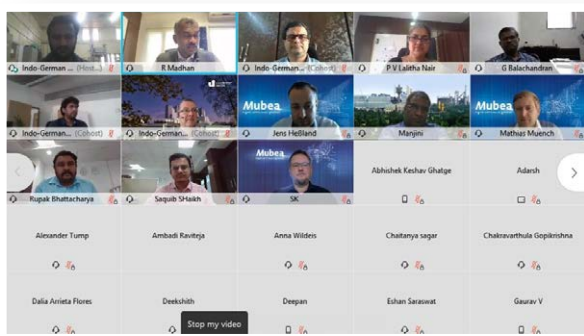

Inaugural Session



Technical Session

Through this workshop, innovative ideas were cultivated for the development of new generation High Strength Steel (HSS). In-depth scientific advancements as well as technological requirements were also discussed.

High-performance metallic materials for energy storage and power generation (MATAPP-2021)

22-23 April 2021

Indo-German bilateral workshop on High-performance metallic materials for energy storage and power generation (MATAPP-2021) was jointly organised by Vellore Institute of Technology (VIT) & FZ Jülich on 22-23 April 2021. The workshop coordinators were Dr M. Manikandan, VIT and Dr Bernd Kuhn, FZ Jülich GmbH.

While fossil fuel based power plants are being phased out, some avenues are still being explored to increase the efficiency of thermal power plants and reduce the emissions of polluting species. Development of advanced ultra-supercritical power plant technologies is being handled on mission mode in India. In this context, specialty steels and superalloys are being developed and evaluated in both in India and Germany. Solar power generation is the most important type of renewable energy, receiving serious attention in both nations. Here again Concentrated Solar Power (CSP) based power generation has several advantages over the photovoltaic approach.

Thermal energy storage systems become important in this context and special steels and superalloys resistant to Phase Change Materials (PCM) need to be developed. The Workshop covered special metallic materials required for advanced versions of thermal power plants and energy storage systems for CSP technology.

The Workshop created an excellent platform for interaction among experts from around the globe on current status and directions / thrust areas for future in the field of special steels and superalloys for advanced thermal, concentrating solar power and heat storage plants. Close to 250 delegates from all over the globe participated in the Workshop. Dr Ruth Schwaiger, Director at the Institute of Energy and Climate Research, FZ Jülich, Germany, was the Guest of honour. Mr Madhan addressed the inaugural session and briefed about the various programmes initiated by IGSTC to enhance R&D partnership between India & Germany. He also urged the participants to find innovative solutions for renewable energy.



Mr Madhan addressing inaugural session



Dr G. Viswanathan, Chancellor, VIT delivering presidential address



Dr Ruth Schwaiger delivering welcome note

Dr Bernd Kuhn, FZ Julich; Dr G. Sivakumar, ARCI, Hyderabad; Dr Torsten Fischer, FZ Jülich; Dr Hongcai Wang, Ruhr-University Bochum, Dr S K Jha, Chairman and Managing Director, MIDHANI, Hyderabad were some of the eminent speakers who delivered talks during this two day

workshop. The workshop deliberations resulted in forging an academia-industry partnership to take stock of latest development and strategies to be adapted with reference materials for advanced thermal power plants and thermal storage systems based on concentrated solar power.

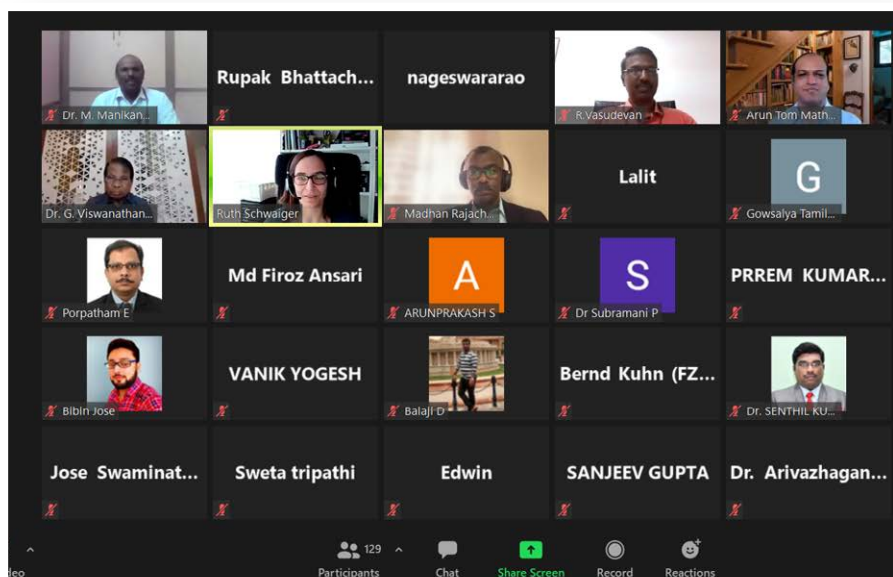

IGSTC partners meet

IGSTC organised a virtual partners meet for projects under Call 2018 & Phase 2 projects of Call 2014 and 2015 on 8th & 12th January 2021 respectively. The purpose of the meeting was to network with other partnering scientists and to interact with the IGSTC staff. Eight projects

presented their progress, deliverables and activities undertaken by them. There was an interactive session at the end of meet where constructive discussions and suggestions on matters relevant to collaborative research and funding took place



Call 2014 & Call 2015 (Phase 2) projects partners meet

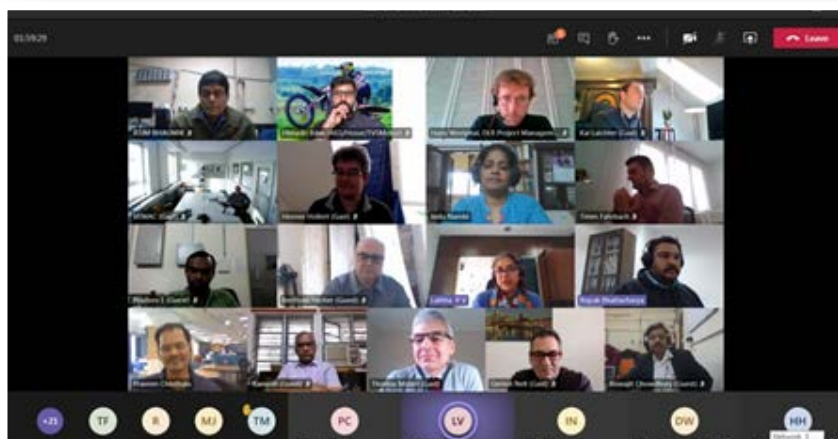

Call 2018 projects partners meet

Robotomation – symposium for robotic automation trends in manufacturing

German Machinery and Plant Manufacturers Association (VDMA) organised the Robotomation – Symposium for robotic automation trends in manufacturing on the 19th February 2021 at The Taj City Centre, Gurgaon. Participants from Indian Tier 1-Automotive, Tyre & Wheel Making Industry, Machine Tool, Food & Beverages and Water industry attended

the prestigious event. Director, IGSTC was a panelist on the session "Role of Robotics + Automation for the Manufacturing Industry". He explained the role of IGSTC acting as an interface between academia and industry. He also briefed about the various opportunities of IGSTC through which industry can participate in bilateral projects.



Mr Madhan addressing the symposium



Panelists on robotic & automation

Indo-German forum on cities & climate

The annual Indo-German Forum on Climate and Cities of the DWIH New Delhi, was held on 16-17 March 2021. It addressed the multifaceted topic of urbanisation and climate-change. IGSTC participated in the event through a virtual booth. The Forum brought together about 35 scientists, decision-makers, and professionals from different

disciplines mainly from India and Germany but also from Australia, the EU, South Africa, and South Asia, to present research projects and analysis on the relationship of cities and climate. IGSTC showcased its programs and other activities in the event. Around 50-70 participants visited the IGSTC virtual booth.



Indo-German Science & Technology Centre

IGSTC Secretariat

Plot No. 102, Institutional Area
Sector - 44, Gurgaon - 122003, India
Tel: +91-1244929400

German Project Office

German Aerospace Center (DLR-PT)
Heinrich-Konen-Str. 1, 53227 Bonn, Germany
Tel: +49-22838211473

 info.igstc@igstc.org

 <https://twitter.com/INDOGSTC>

 <https://www.linkedin.com/company/igstc>

 <https://www.facebook.com/IGSTC.IndoGerman/>